

COMPLEX MADE SYMPLA



reddot design award
winner 2012



SYMPLA™
SYSTEM MOVING PLATFORM

Introducing the rig that takes your filming to the next level.
Set-up and adjust in seconds. Faster, smarter, SYMPLA.



Manfrotto
Imagine More

SYMPLA™

SYSTEM MOVING PLATFORM

Hybrid HDSLR cameras and ever-smaller pro camcorders are changing videography dramatically; yet along with the obvious advantages and opportunities presented by smaller, lighter cameras, come new problems to solve: as ENG camera operators use smaller cameras, and photographers are expected to shoot broadcast-quality video footage on their HDSLRs, both groups are finding that their camera equipment doesn't have the ergonomic form for steady shoulder-mounted or hand-held footage; nor the attachment points for monitors, batteries, light-modifiers or accessories; nor the inherent weight that helps minimise camera shake.

SYMPLA is Manfrotto's solution to those problems: a professional modular video rig system that extends and complements new cameras, allows for stable support and framing, supports essential accessories features, offering versatility and high performance as well as comfort, safety and much simpler and faster set up than existing rigs.

SYMPLA is built for flexibility and speed, so you can change anything and everything easily and quickly: hand grip positions, counterbalance, camera body, lens, accessories, filters, light-shielding angle; shoulder-supported, hand-held, or tripod/monopod-mounted... whatever you need to get the shot, the second you need it.

SYMPLA is quick to fine-tune, so even when you need to make changes to your rig on-location and mid-shoot, SYMPLA's minimal locks and tool-free adjusters will let you get back to shooting quickly.

Thanks to our revolutionary camera remotes which fit the rig handgrips, SYMPLA allows precise fingertip control of framing and camera functions without losing the grip position and keeping your eyes on the frame, helping you capture stable, usable, creative footage. And SYMPLA can quickly be extended: whether you start from one of our kits, or from single components, you can build the exact rig you need for the shot, as soon as you need it.



SYMPLA™

SYSTEM MOVING PLATFORM

With a wide range of components for different applications - like the unique Flexible Mattebox, the versatile Variable Plate, the innovative Remote Controls - customised SYMPLA supports and accessories can be assembled in seconds, without tools.

You can shoot shoulder-mounted for responsive eye-level footage; with innovative supports like the Fig Rig that open up new creative possibilities; or on the stable platform of a monopod or tripod... and you can switch quickly between them all.

SYMPLA products are developed and engineered for ease and speed of set-up, and to make configuration of the basic components as flexible and fast as possible; so even a change of application, like completely changing the mattebox system from tripod-mounted to shoulder-supported, is quick and easy.



SYMPLA™

SYSTEM MOVING PLATFORM



SYMPLA's name says it all - this is a professional rig system that removes the complexity present in so many others: we reduced the variety of components and streamlined the system without limiting what can be done with it. We removed screws, grouped locking levers and applied industry-wide standards to make it easy to set up and intuitive to use. And then we made it comfortable and stable to hold, with ergonomically positionable elements, carefully studied controls and innovative remote units that make you, your camera and your SYMPLA rig work as one.

- A: set-up and adjust any camera in seconds
- B: react quickly to changing contexts and creative inspiration
- C: shoot from any angle even under challenging light conditions



reddot design award
winner 2012



B



A



C

SYMPLA™ PLATES

SYSTEM MOVING PLATFORM

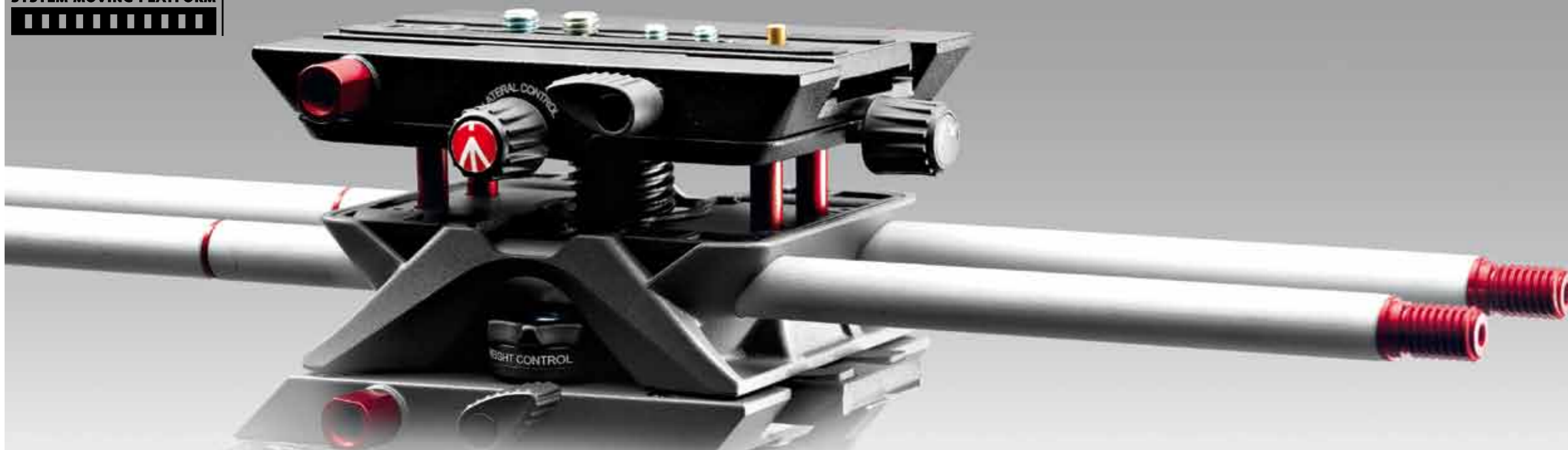

At the heart of the SYMPLA system are the Plates, which fix the camera to SYMPLA rigs. Both versions allow front-back positioning; the Variable Plate also offers precise vertical and lateral adjustment, so lenses can be aligned with the Flexible Mattebox, or the camera viewfinder with your eye. Precision-cast in aluminium with durable steel components, SYMPLA Plates have no hard-to-access screws and require no tools for fitting or adjustment. Camera attachment is via Manfrotto's most popular quick release video plate (secured by a secondary safety lock) so swapping cameras, or moving a camera between SYMPLA and a Manfrotto video head is easy and fast. Using a sliding plate also means that additional front-back camera position adjustment is possible to take long lenses viewfinders, batteries and accessories into account. Under the Plate are two 3/8" threads for attaching the entire rig, or individual components like the Flexible Mattebox, to a monopod, tripod or video head. Easy-Link fittings on the Plate sides also support Magic Arms, light modifiers, LED lighting units or external monitors.



SYMPLA FIXED PLATE MVA513W

The Fixed Plate slides and holds the camera on SYMPLA rails for front-rear positioning. A single, easy to use repositionable ratchet lock blocks movement. No tools are required for plate adjustments.

- Camera attachment: Manfrotto 504PLONG quick release video plate.
- Accessory attachments: 2 x 3/8" Easy Link
- Underside: 2 x Female 3/8" threads (for monopod, tripod or video head QR plate)
- Materials: Durable aluminium and steel construction
- Load capacity: 5 kg (11lbs)
- Weight: 0,96 kg (2.2 lbs)



SYMPLA VARIABLE PLATE MVA515W

The Variable Plate allows precise, fast camera positioning on 3 axes of movement. The plate has a repositionable ratchet quick-lock for each axis, and an intuitive fingertip control each for vertical and lateral geared micro-adjustments. The camera is held safely in place even before its position is locked down, allowing for single-handed adjustments and fine-tuning. The Variable Plate offers the versatility essential for alignment of different camera and lens combinations with the SYMPLA Flexible Mattebox, and for comfortable use of viewfinders and accessories. No tools are required for plate adjustments.

- Camera attachment: Manfrotto 504PLONG quick release video plate.
- Accessory attachments: 2 x 3/8" Easy Link
- Underside: 2 x Female 3/8" threads (for monopod, tripod or video head QR plate)
- Materials: Durable aluminium and steel construction
- Load capacity: 5 kg (11lbs)
- Weight: 1,16 kg (2.55 lbs)

• VARIABLE PLATE - TOP VIEW



• VARIABLE PLATE - BOTTOM VIEW



• VARIABLE PLATE - ADJUSTMENT RANGE

How far the camera can move in each direction.



SYMPLA™ UNIVERSAL MOUNT

SYSTEM MOVING PLATFORM



The multi-purpose Universal Mount is a self-hanging clamp that slides along SYMPLA rails and locks in position with a single locking lever. The Universal Mount is the basic structural element for numerous SYMPLA components and it also supports external accessories via standard 3/8" threads.

• OTHER SYMPLA COMPONENTS BUILT AROUND THE UNIVERSAL MOUNT

SYMPLA UNIVERSAL MOUNT MVA517W

The Universal Mount has an "open hook" design, which allows it to be inserted and hung on the SYMPLA rails from below, even between other elements that have already been positioned. Because it's self-supporting even when unlocked, it stays safely attached to the rails at all times. A single, repositionable locking lever conveniently blocks the Universal Mount solidly against both rails with one movement. The Universal Mount is extremely versatile, thanks to its 4 x 3/8" female threads and 2 x 1/4" female threads, which can be used to attach arms, adaptors and other components and accessories.



- Construction: aluminium fusion for reliability and robustness.
- Weight: 0,29 kg (0.63 lbs)



SYMPLA™ BODY AND LENS SUPPORTS

SYSTEM MOVING PLATFORM



The camera body support and the lens support elements create a more stable, vibration-free platform for shooting. Filming with long telephoto lenses on HD/SLR cameras or camcorders means using the lens L-bracket as the connection between camera and rig, which creates a less than ideal weight distribution and means that the slightest movement or touch of the camera or lens (such as pressing "Rec", or focusing the lens) produces visible camera shake and vibration that has to be edited or removed in post-production. The body and lens supports are vertically adjustable to rest firmly against the camera body and lens to damp and eliminate vibration, and to make your whole rig more stable and secure. Both supports are rubber-coated to protect camera equipment.

SYMPLA BODY SUPPORT MVA516W

The SYMPLA Body Support has a flat rubber-coated bar that can be raised until it rests solidly against the underside of your camera body in order to stop it from vibrating when the lens L-bracket is being used to connect the camera to SYMPLA. A repositionable ratchet locking lever blocks height adjustment.

- Height range: 0 to 30 mm (1.18") (for a greater height range, an additional SYMPLA V-Offset can be used)

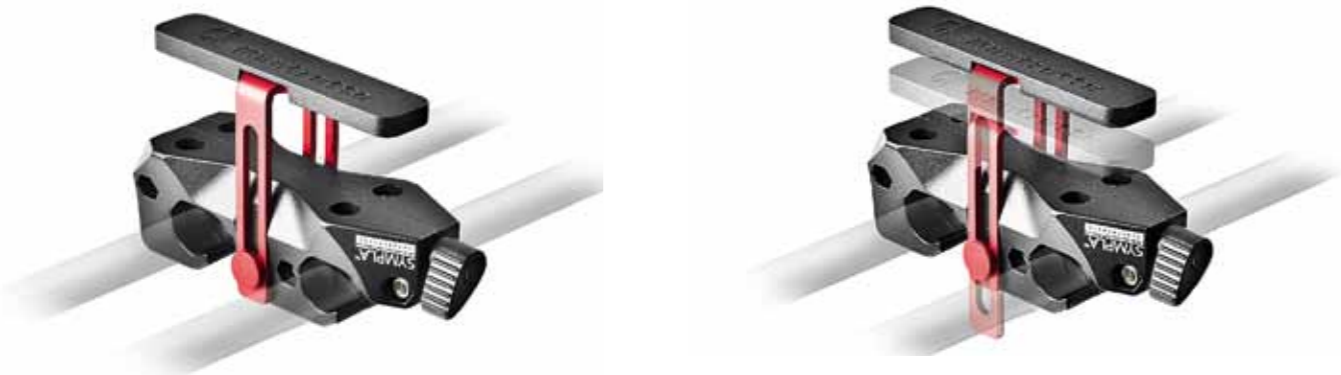

SYMPLA LENS SUPPORT MVA514W

The SYMPLA Lens Support has a rubber-coated V-profile element that can be raised until it rests solidly against the lens in order to stop it from vibrating when the lens L-bracket is being used to connect the camera to SYMPLA. A repositionable ratchet locking lever blocks height adjustment.

- Height range: 0 to 30 mm (1.18") (for a greater height range, an additional SYMPLA V-Offset can be used)



SYMPLA™ FLEXIBLE MATTEBOX

SYSTEM MOVING PLATFORM



High quality digital sensors and photo lenses need careful control of incoming light and the SYMPLA Flexible Mattebox is a universal light-hood, a positionable anti-glare/anti-reflection shield and a double 4x4" filter-holder, all rolled into one. A key component of the SYMPLA system, the Flexible Mattebox is designed for speed and ease of use, with its 90° hinge allowing fast lens changes and single-lock, tool-free height and front-back movements for equally speedy alignment.

SYMPLA FLEXIBLE MATTEBOX MVA512W



The SYMPLA Flexible Mattebox is designed for cameras with interchangeable lenses; fitted on a Universal Mount, it slides backwards and forwards along SYMPLA rails, and has 50mm (1.96") of vertical travel so that it can be aligned with lenses of different lengths and heights. The mattebox has an elasticated textile lens seal that fits common lens diameters, and is built around a 90° swivel joint, which rotates the mattebox out of the way for fast lens changes. The weight of the Flexible Mattebox is fully supported by the SYMPLA rails (not by the camera lens) reducing stress on the camera's easily-damaged lens mount.

Two 4x4" filters can be held in front of the lens –one of the filter holders rotates through 360 degrees, to allow a polarising (or graduated) filter to be angled correctly.

The concertina rubber light hood is opened or closed, partially or fully, in an instant. More versatile than the traditional French flag design, it can shield unwanted directional glare from any angle without blocking light from the rest of the scene; in many cases, that can make a direct difference to the f-stop that can be used. Because the hood is flexible in length, it's universally compatible with lenses from wide-angle to tele. It packs flat for transportability and, when open, protects the lens against knocks and scrapes. Being made of rubber, it won't hurt anyone who accidentally bumps into it... which means it's much safer for use in crowded places or close to sporting events. Another benefit of the flexible hood is that it can be used when shooting at an angle through glass: position the camera and extend and angle the hood so it forms a seal against the glass, thereby cutting out reflections. Repositionable ratchet locks on all movements.

• THE HOOD OPENS TO VARIOUS LENGTHS DEPENDING ON LIGHT AND LENS ANGLES



• THE HOOD CAN SHIELD AGAINST GLARE FROM ANY SPECIFIC DIRECTION WITHOUT BLOCKING LIGHT FROM OTHER ANGLES



SYMPLA™ FLEXIBLE MATTEBOX-FEATURES

SYSTEM MOVING PLATFORM



- 90° swivel joint rotates the mattebox out of the way for fast lens changes.



- Eliminates reflections when shooting at an angle through glass.



- Fitted on a Universal Mount with vertical offset (travel: 50 mm (1.96")) for alignment with lenses. The Flexible Mattebox is supported by the SYMPLA rails avoiding stress on the camera's lens mount.



- 2 precision-machined aluminium holders for 4x4" photographic filters (1 fixed holder, 1 rotating holder for polarisers). Elasticated textile lens seal fits common lens diameters.

SYMPLA™ ADJUSTABLE HANDLES

SYSTEM MOVING PLATFORM



Every person is different in height and build, and when it comes down to something as critical as a professional video rig, everyone has their own preferences for comfort and support. The handles are where the ergonomics and positioning flexibility of SYMPLA really come into play: mounted on ball joints inspired by Manfrotto's professional photographic heads, they can quickly be set wider, closer, vertically, horizontally or at any intermediate angle, rotated 360°... even upside-down – in whatever position you find most stable and most comfortable.



SYMPLA ADJUSTABLE HANDLES
MVA518W

SYMPLA Adjustable Handles are fitted on a Universal Mount by two arms that can be angled independently. The handles are mounted on pivoting ball joints for easier adjustment: a twist of the single locking dial on each handle loosens or blocks all movement, allowing them to be rotated freely and quickly set at the exact position and angle required. The handles can be set in customary vertical or near-vertical positions, but also horizontally like motorbike handlebars. When a SYMPLA rig is mounted on a video head, the handles can be used as double pan bars. Thanks to the Universal Mount, the Adjustable Handles can be easily removed and inverted to the upside down configuration. The PVC-free Adjustable Handles are supplied with two metal spacers that can be fitted to lengthen the arms. The same spacers also adapt the handles for use with Manfrotto's clamp and joystick remote control units.



SYMPLA™ FIG RIG

SYSTEM MOVING PLATFORM



An ingenious idea from film director Mike Figgis, the Fig Rig is an alternative camera support for video, which uses the wider grip of a “steering wheel” to help stabilise handheld footage and allow unusual shooting angles – ground level or overhead – while also protecting the camera, which is centrally-mounted. The horizontal bar and wheel itself also offer space for other accessories.

FIG RIG SYMPLA VERSION MVA522W

The SYMPLA version of the Fig Rig has a Universal Mount in the centre of the wheel so that SYMPLA rails can be fitted, allowing other components and kits such as the Long Lens Support or Flexible Mattebox to be attached.

SYMPLA™ HD SLR ELECTRONIC REMOTE CONTROLS

SYSTEM MOVING PLATFORM
■■■■■■■■■■



These are the world's first true electronic HD SLR remote controls. By interfacing with camera and lens firmware directly, these two units promise real innovation in the field of HD SLR filming: they circumvent the need for any physical interface between follow-focus equipment and the camera lens, and instead wire directly into the camera body to use the internal focus control systems. The advantages are obvious: lenses can be swapped easily without extra hardware or adjustment, nothing jolts the camera unexpectedly during follow-focus, one-man camera operation is easier, and control at a distance is as simple as extending the cable between the camera and the remote.

By interfacing with the camera's protocols, not only focus control operation as in- and out- focus point pre-sets, one-touch auto-focus and focusing speed can be managed by the remote control unit... many other camera functions can also be operated, including record start & stop, photo/video switching and shutter release, live view, digital zoom, aperture and exposure, ISO settings and more besides, depending on the version.

There are two models of remote control: a basic, compact clamp version, and a deluxe joystick control with built-in LCD screen. Differences aside, both models are perfectly integrated into the SYMPLA system, fitting comfortably on (or in place of) an Adjustable Handle and allowing fingertip control of key camera functions without moving the hand from the grips, in turn making support more stable and secure. Both models are also future-proof, with USB connections to allow occasional firmware upgrades. The USB connection is also what plugs into the HD SLR camera body in order to command it.

• EXAMPLE CONFIGURATIONS OF THE REMOTE CONTROL UNITS



SYMPLA™ HD SLR ELECTRONIC REMOTE CONTROLS

SYSTEM MOVING PLATFORM



HD SLR CLAMP-ON REMOTE CONTROL MVR911ECCN

By interfacing directly with camera protocol via USB, the clamp-on electronic remote allows focus operations and main camera functions to be controlled from an extremely compact unit that attaches to a SYMPLA grip or other bar/pipe, remotely and without direct contact with the camera lens. This means lenses can be swapped easily without adjustment, camera movement is reduced to a minimum, and one-man camera operation is easier. In- and out- focus points and focusing speed can be set, auto-focus used, recording started & stopped, still images taken, and more besides. Fingertip control of key camera functions without moving the hand from the SYMPLA handles makes support more stable and secure.

- 3-step, ultra-precise focus speed
- Fixed or variable focus control modes
- Customizable focus speed limit
- Focus Memory settings
- Live View control
- Auto Focus control
- Live View Digital Zoom control
- Video recording start/stop
- Photo shutter release
- Remote control battery status
- Customizable focus direction
- Recording LED
- Video and Photo LED
- Clamp fits the spacer supplied with SYMPLA Adjustable Handles, or round tubes/pipes/bars/pan bars between 12mm (0.47") and 23mm (0.90") in diameter

Compatible with Canon's EOS 5D Mark II, EOS 1D Mark IV, EOS 7D, EOS 60D, EOS 600D/Rebel T3i/Kiss X5, EOS 550D/Rebel T2i/Kiss X4 and EOS 500D/Rebel T1i/Kiss X3 - at the time of publication.



FRONT

- Autofocus
- Live View and Focus Memory 1
- Digital Zoom and Focus Memory 2
- Rec/Stop (video) and Shutter release (photo)
- Focus knob



LEFT SIDE

- Focus speed limit dial
- Focus mode switch – variable or fixed



RIGHT SIDE

- On / Off switch



TOP SIDE

- USB connection - to camera USB port.
- Extended length of supplied cable: 50cm
- Power connection to battery housed in lower shell of the clamp



BACK

- Battery housing (2 x AAA)

SYMPLA™ HDSLR ELECTRONIC REMOTE CONTROLS

SYSTEM MOVING PLATFORM

HDSLR DELUXE REMOTE CONTROL MVR911EJCN

The Deluxe Remote Control is designed to be used as one of the hand grips of a SYMPLA shoulder support, where it means that a single camera operator can properly support the weight of the camera and rig to ensure smooth, accurate framing and movement, while also controlling all camera functions, without removing either hand from the rig. The Deluxe version can also be used hand-held and away from the camera and its support, it can be attached to video head pan bars or set up in any number of alternative configurations.

It electronically controls focus and both main and advanced camera operations and settings. The LCD screen on Manfrotto's Deluxe version remote relays general information from the camera, such as battery charge level, white balance temperature and memory card status - especially useful if the camera's on-body screen is inaccessible.

- 3-step, ultra-precise focus speed
- Fixed or variable focus control modes
- Customizable focus speed limit
- Focus Memory settings
- Live View control
- Auto Focus control and Auto Focus point selection
- Live View Digital Zoom control
- Video recording start/stop
- Photo shutter release
- Remote control and camera battery status
- Customizable focus direction
- ISO
- Shutter speed
- Aperture
- Colour temperature
- Exposure level

Compatible with Canon's EOS 5D Mark II, EOS 1D Mark IV, EOS 7D, EOS 60D, EOS 600D/Rebel T3i/Kiss X5, EOS 550D/Rebel T2i/Kiss X4 and EOS 500D/Rebel T1i/Kiss X3 - at the time of publication.

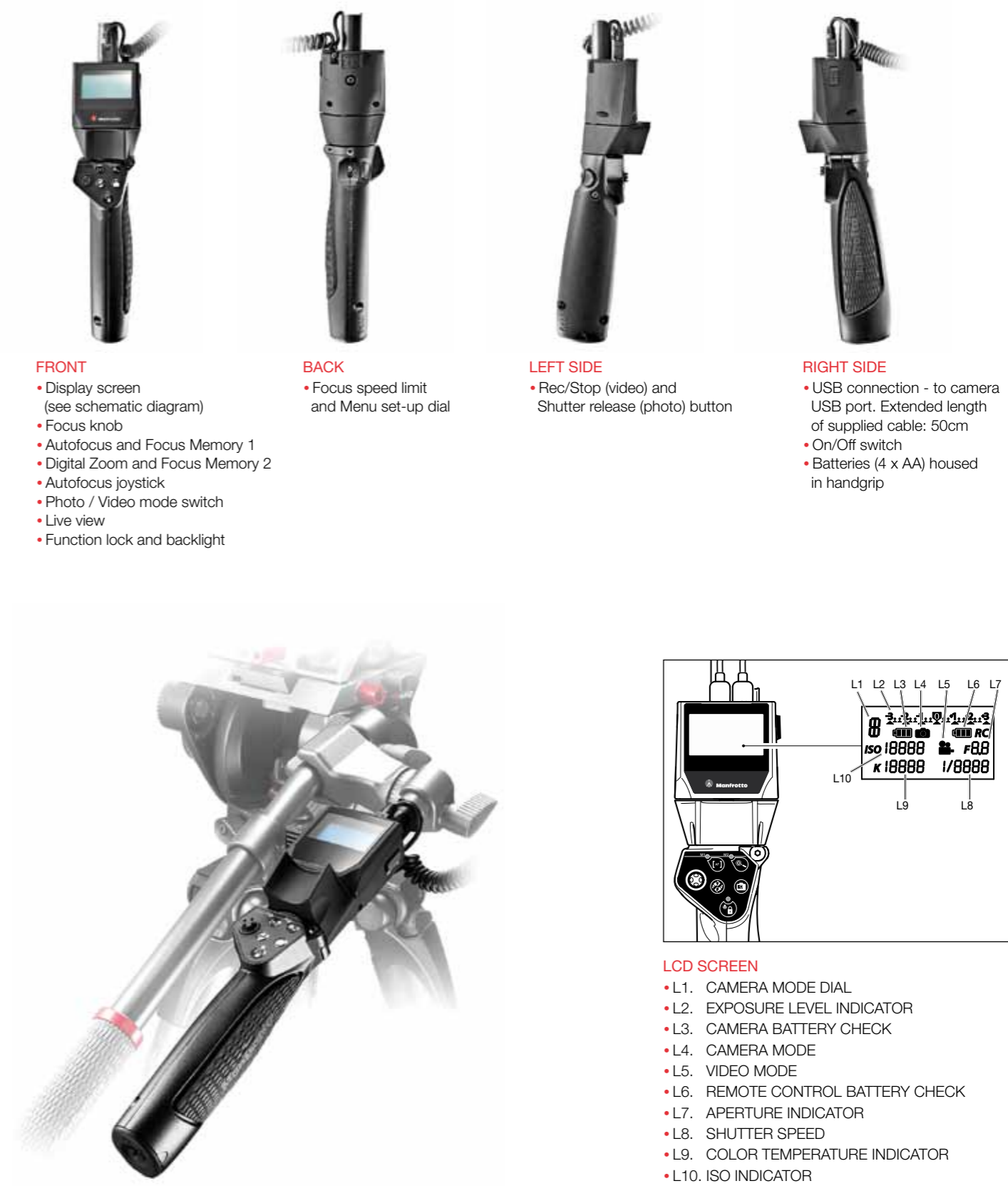

FRONT

- Display screen (see schematic diagram)
- Focus knob
- Autofocus and Focus Memory 1
- Digital Zoom and Focus Memory 2
- Autofocus joystick
- Photo / Video mode switch
- Live view
- Function lock and backlight

BACK

- Focus speed limit and Menu set-up dial

LEFT SIDE

- Rec/Stop (video) and Shutter release (photo) button

RIGHT SIDE

- USB connection - to camera USB port. Extended length of supplied cable: 50cm
- On/Off switch
- Batteries (4 x AA) housed in handgrip

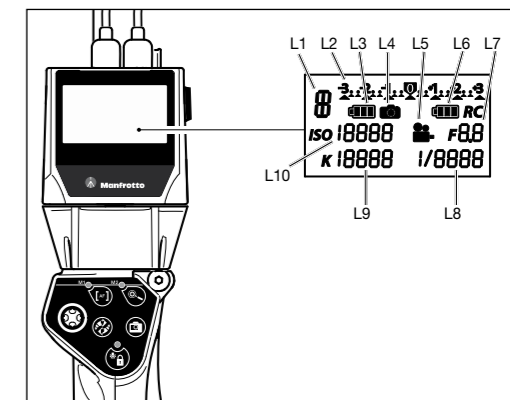

LCD SCREEN

- L1. CAMERA MODE DIAL
- L2. EXPOSURE LEVEL INDICATOR
- L3. CAMERA BATTERY CHECK
- L4. CAMERA MODE
- L5. VIDEO MODE
- L6. REMOTE CONTROL BATTERY CHECK
- L7. APERTURE INDICATOR
- L8. SHUTTER SPEED
- L9. COLOR TEMPERATURE INDICATOR
- L10. ISO INDICATOR

SYMPLA™ SYSTEM MOVING PLATFORM

ADDITIONAL COMPONENTS

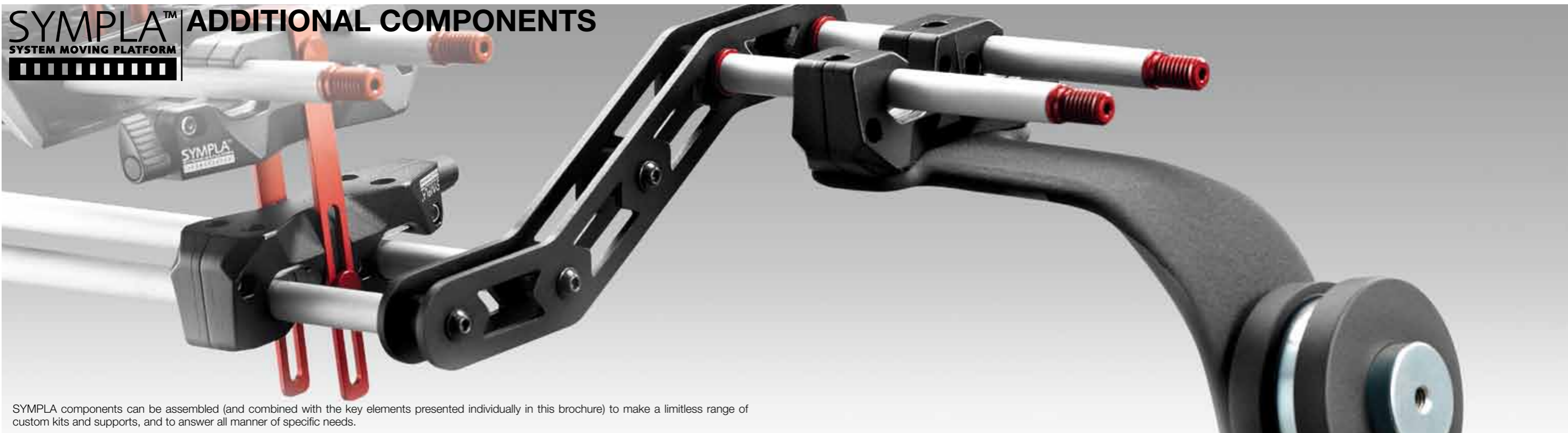

SYMPLA components can be assembled (and combined with the key elements presented individually in this brochure) to make a limitless range of custom kits and supports, and to answer all manner of specific needs.



SYMPLA H-OFFSET
MVA519W

The H-Offset is normally used to join an off-centre SYMPLA Shoulder Pad to a set of SYMPLA rails directly in front of the camera operator, so that the camera viewfinder or LCD screen can be more comfortably positioned and the weight of the camera and rig more ergonomically distributed.



SYMPLA V-OFFSET
MVA524W

The V-Offset is used when a large height difference needs to be bridged, for example when using a very long tele lens with a tall front lens element.



RODS - 150MM
MVA523W

A pair of 150mm (5.9") long SYMPLA rails, including 1/2"-13UNC screw junctions, with standard 15mm (0.59") diameter.



RODS - 300MM
MVA520W

A pair of 300mm (11.8") long SYMPLA rails, including 1/2"-13UNC screw junctions, with standard 15mm (0.59") diameter.



SYMPLA SHOULDER PAD
MVA511W

A non-slip, rubber covered shoulder support fitted to a SYMPLA Universal Mount for comfortable, safe, solid hand-held shots. The part of the Shoulder Pad that normally goes behind the camera operator's back has a 3/8" thread for one or more SYMPLA counterweights to balance the front-mounted load.



COUNTERWEIGHT
MVA521W

Each counterweight weighs 1,6kg (3.52 lbs), and screws securely on to the SYMPLA Shoulder Pad via 3/8" thread. Counterweights can also be stacked to offset very unbalanced loads.

SYMPLA™ SYSTEMS

SYSTEM MOVING PLATFORM

Although the possibilities are endless for combining SYMPLA components to make totally custom rigs and supports, there are some basic needs that apply to the vast majority of HD/SLR videographers, so we put together a few conveniently ready-to-go SYMPLA systems.



SYMPLA SHOULDER SUPPORT SYSTEM
MVA511WK

Sympla Shoulder Support System allows support of camera equipment on your shoulder, with swivel-joint handles for perfect control and flexibility. The Shoulder Support is ideal for use with Manfrotto's new HD/SLR Remote Controls, which put camera functions at your fingertips while letting you keep a firm grip on both handles.
Kit comprises: 300 mm Rods (2), Sympla Shoulder Pad, Sympla Variable Plate, Sympla Adjustable Handles, Sympla H- Offset, Clips (2).
We recommend: Counterweight, Mattebox, Remote Controls.







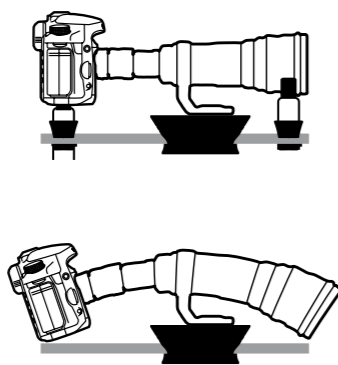













SYMPLA FLEXIBLE MATTEBOX SYSTEM
MVA512WK

The multi-purpose Flexible Mattebox holds 4x4" filters and protects the lens from stray light, while also permitting fast lens changes. The included Variable Plate component, with its vertical and lateral micro-adjusters, allows easy and precise alignment of the lens with the Flexible Mattebox. Compatible with all Manfrotto Video Heads.
Kit comprises: 300 mm Rods, Sympla Flexible Mattebox, Sympla Variable Plate, Clips.
We recommend: Lens Support, Remote Controls.



**SYMPLA LONG LENS SUPPORT SYSTEM
MVA513WK**

The Long Lens Support reduces the vibrations generated while shooting with long lenses and gives a rigid, stable platform for filming with any camera/lens combination. Compatible with all Manfrotto Video Heads. Kit comprises: 300 mm Rods (2), Sympla Variable Plate, Sympla Lens Support, Sympla Body Support, Sympla V-Offset, 150 mm Rods and Clips. We recommend: Offset, Shoulder Pad, Adjustable Handles.

MODEL	ITEM NAME	FEATURES	BENEFITS	PAGE	
 MVA515W	1 SYMPLA VARIABLE PLATE	the core of the system, a quick release plate with micrometric knobs for each axis of movement, without screws and bolts hence no need for tools	set-up and adjust any camera in seconds	8	
 MVA518W	2 SYMPLA ADJUSTABLE HANDLES	swivel-joint hand grips with a single control knob for all adjustments	easily fits your most comfortable operating position	18	
 MVA512W	3 SYMPLA FLEXIBLE MATTEBOX	flexible light hood and filter-holder that enhances image quality and controls flare and glare	shoot from any angle even under challenging light conditions	14	
 MVR911ECCN	4 HDSR CLAMP ON REMOTE CONTROL	USB remote that controls the main features of specific cameras - including focus - with one thumb and without touching the camera	react quickly to changing contexts and creative inspiration	24	
 MVA511W	SYMPLA SHOULDER PAD	shoulder mount that comfortably supports and balances the rig with the camera and all its accessories	secure and smooth shooting without physical strain	29	
 MVA522W	FIG RIG SYMPLA VERSION	"steering wheel" camera support with multiple gripping points	hand-held filming, at the most unusual angles	20	
 MVA517W	SYMPLA UNIVERSAL MOUNT	clamp that connects all Sympla parts and hooks directly onto the rig in any position	modify the system without losing your chosen set up	10	
ADDITIONAL COMPONENTS					
 MVA516W	SYMPLA BODY SUPPORT	additional support for extra camera body stability and reduced vibration	assemble the system that best suits your needs	20	
 MVA514W	SYMPLA LENS SUPPORT	additional support for extra camera lens stability and reduced vibration		22	
 MVA519W	SYMPLA H-OFFSET	joining element that allows rail alignment to be shifted horizontally		22	
 MVA524W	SYMPLA V-OFFSET	joining element that allows rail alignment to be shifted vertically		22	
 MVA523W	RODS 150 MM	basic structural and supporting element of the rig - short version		22	
 MVA520W	RODS 300MM	basic structural and supporting element of the rig - long version		23	
 MVA521W	COUNTERWEIGHT	attaches to shoulder pad to balance the front-positioned weight of the rig, camera and accessories		23	
 MVR911EJCN	HDSR DE LUXE REMOTE CONTROL	USB remote with display that controls most features of specific cameras - including focus - with one thumb and without touching the camera		react quickly to changing contexts and creative inspiration	26
 MVA513W	SYMPLA FIXED PLATE	quick release plate		attach any camera in seconds	28
STARTING KITS		COMPONENTS		SUGGESTED USE	
 MVA511WK	SYMPLA SHOULDER SUPPORT SYSTEM	shoulder pad, variable plate, rods and clips, handles, horizontal offset - counterweight sold separately	stable eye-level footage on the move	30	
 MVA512WK	SYMPLA FLEXIBLE MATTEBOX SYSTEM	mattebox, variable plate, rods and clips	assemble mattebox around any camera	31	
 MVA513WK	SYMPLA LONG LENS SUPPORT SYSTEM	variable plate, rods and clips, body and lens support, vertical offset	reduce vibrations on cameras with long lenses	32	

SYMPLA™ SYSTEM MOVING PLATFORM

EXAMPLE CONFIGURATIONS

Example custom rigs and supports made from SYMPLA components.



The skills of the world's best photographers and video operators are brought together by Manfrotto in an innovative on-line platform.

Featuring:
Hary De Zitter,
Joe McNally,
Bill Frakes,
Drew Gardner,
Roberto Bigano,
Ami Elsius,
Marc de Tollenaere,
Kristoff Ramon,
David Duchemin,
Milko Marchetti,
Uri Golman,
Adam Barker,
Kazuyuki Okajima and many others.



Manfrotto
SCHOOL OF XCELLENCE
manfrottoschoolofexcellence.com